











Unpacking

Please make sure the package contains the following items:

-  Plastic wall anchors x 4
-  ST4x20 screw x 4
-  M4x30 screw x 4
-  M3x6 screw x 1
-  M3x10.5 screw x 1
-  Allen Wrench x 1
-  10 Pin cable x 1
-  11 Pin cable x 1
-  Wall bracket x 1
-  C317X x 1

Product Overview

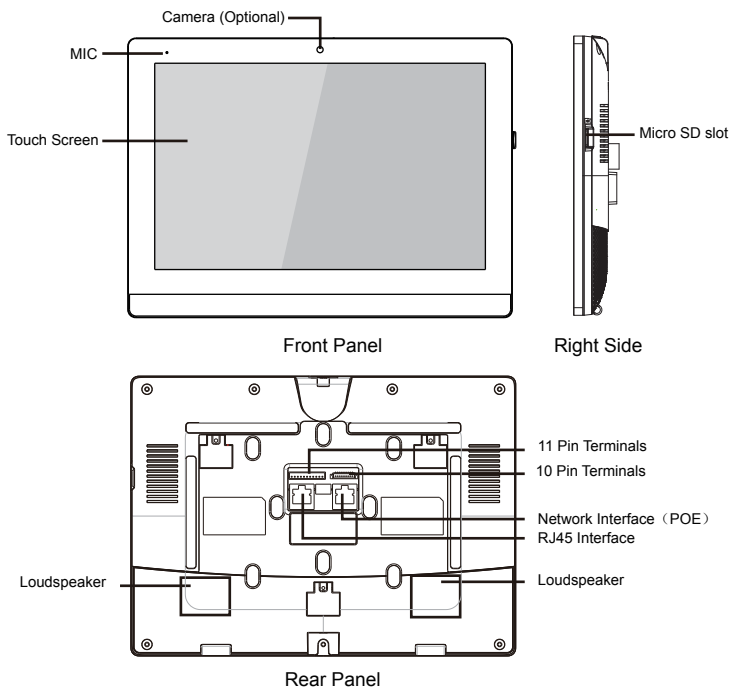

Installation

Step 1: Wall Bracket Installation

Without embedded box in the wall

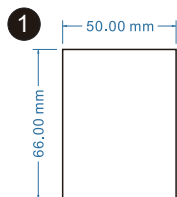

According to the position of the cable in the wall, dig out a square hole (height*width*depth = 66*50*50 mm) that can accommodate all cables.

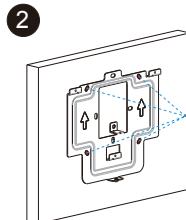

Align the square holes of the wall bracket with the holes previously dug, and then mark the four fixing holes of the wall bracket on the wall.

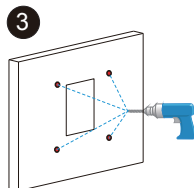

Take down the bracket and drill the four marked fixing holes on the wall (5 mm drill bit required).

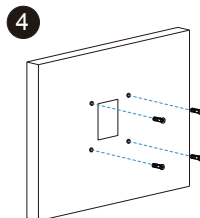

Once the fixing holes were made, insert plastic wall anchors provided.

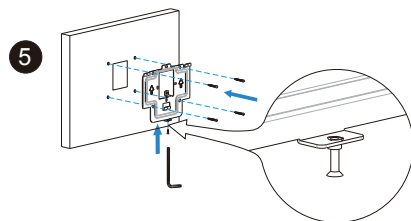

Twist M3x10.5 screw into the bottom hole of the bracket until the tail of which align to the edge. Then fix the wall bracket on the wall with four ST4x20 screws. If there is a ground wire to be connected, use M3x6 screw to fix it on the wall bracket.

With embedded box in the wall

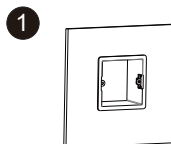

Make sure all cables in the embedded box .

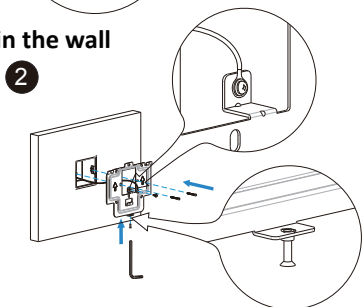

Twist M3x10.5 screw into the bottom hole of the wall bracket until the tail of which align to the edge. Then fix the wall bracket on the wall with two/four M4x30 screws. If there is a ground wire to be connected, use M3x6 screw to fix it on the wall bracket.

C317X Quick Guide

Step 2: Device Mounting

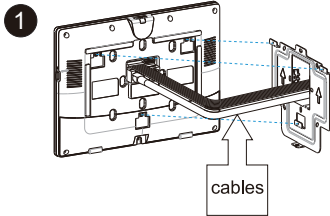

Connect the cables to device.

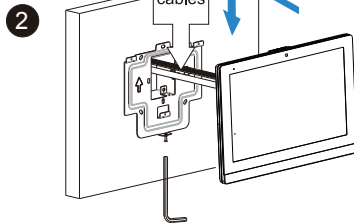



Push down to fix the device securely. Use the Allen wrench to tighten the device with one M3x10.5 screw.

Configuration

1. Access basic information: After setting up network and power, enter **More** -> **System Info** to check Account, Network, Version status.
2. Access the Website: Launch a browser and type in the IP address then enter the username and password to login. (username/password: admin /admin by default)
3. Account Registration: On web UI, go to the path: **Account** -> **Basic** page to fill in the account information, click Submit to confirm. (Please refer to user manual for more information)

Operation

Make a call:

Press Intercom icon  , enter the callee's number or room address, then choose Audio  or Video  mode to make out.

Receive a call:

Press  on the incoming interface to pickup the incoming call.

Unlock

During the talk, called party can press Unlock Key  on the talking interface to unlock the door.

Monitor

Press Live View icon  to receive the video from the IPC any time.

Device Wiring

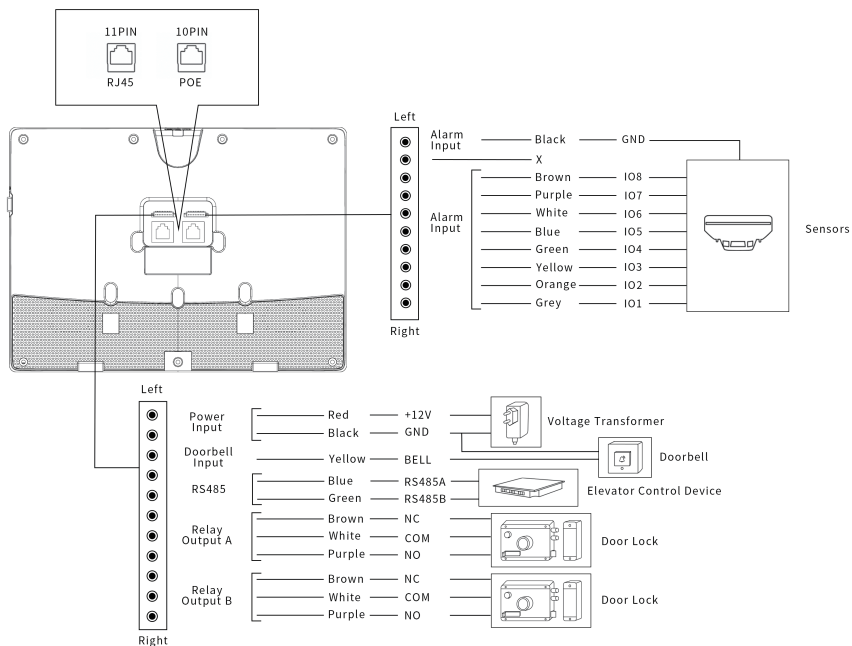

Notice Information

Information contained in this document is believed to be accurate and reliable at the time of printing. This document is subject to change without notice, any update to this document can be viewed on Akuvox's website: <http://www.akuvov.com> ©Copyright 2019 Akuvox Ltd. All rights reserved.

AKUVOX (XIAMEN) NETWORKS CO., LTD.

ADD: 10/F, NO.56 GUANRI ROAD, SOFTWARE PARK II, XIAMEN 361009, CHINA

www.akuvov.com

